

SNOW

24020/80

PLAFÓN

Inspirada en las huellas del viento en la nieve, reúne formas orgánicas, naturaleza y frescura. Alma metálica y cubierta de textil blanco óptico para deslizar la luz y envolver cualquier estancia.

SURFACE LIGHT

Wind blowing on the snow. Waving surface combining peaceful feeling and innovative design. Suitable on any surface, vertical, horizontal or sloping. Removable stretching fabric covering a metal frame.

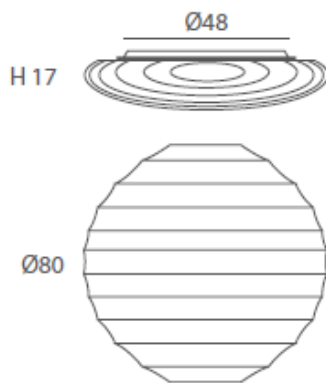





REF.
24020/80

PLAFÓN / SURFACE LIGHT
IP20

MATERIAL
Metal y tela elástica /
Metal & stretching fabric

ACABADO / FINISH
Blanco óptico / Optical white

INSTALACIÓN / INSTALLATION
- E27 LED 4x10W Ø6cm 

- PCB-LED 40W 700mA   
Cálida / Warm 3000K 2400lm
Neutra / Neutral 4000K 2510lm



*(bombillas no incluidas / lamps not included)

 dim 1-10V

 dim DALI

 dim PUSH

* Archivos 3D y ficheros fotométricos disponibles en web / 3D and photometric files available on the web

SNOW

DOBLE ENCENDIDO

MODELO DISPONIBLE CON DOBLE ENCENDIDO (en la instalación PCB-LED 40W) :

MODELS AVAILABLE FOR 2 SWITCHES (For installation PCB-LED 40W):

40W



20W



20W

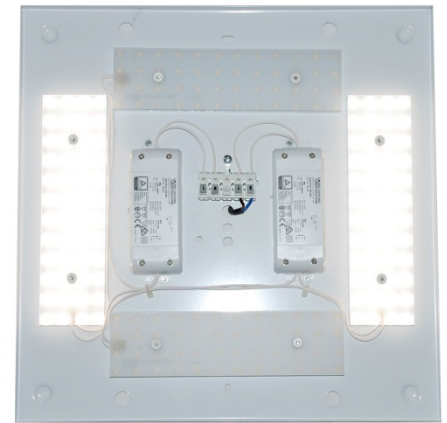

El aparato se suministra así desde fábrica

This is the standard switch configuration supplied from factory if there is not 2-switch request in your order



Teniendo en la instalación dos llaves, se puede pedir desde fábrica con dos encendidos

If installation has possibility of 2 switches, we may supply as per above 2-switch configuration, on request